

**IT1000** — **A B** — **0 0 0**

Base part number

Product level  
Revisions are not  
compatible

Tool revision  
Revisions are  
compatible

Other options:

0 – None (standard)

1 – Feedback system

Trigger options:

0 – Standard thumb trigger

1 – Connection for a remote trigger

(I17490, Foot Control Kit, is  
available to purchase separately)

Packaging options:

0 – Tool with all accessories (standard)

1 – Tool only



# Table of Contents



**IT1000-AB**

**1/4" Tie-Lok® Tool**

<b>Table of Contents</b>	<b>Page</b>
Warranty & Safety Guidelines	3
Air System	4-6
Parts Identification	7,22
Tool Overview	8
Setup and Assembly Instructions	9-11
Remote Operations & Fixturing Tips	12,13
Operating Tips	14
Operating Instructions	15
Troubleshooting	16-20
Maintenance	21-28
Tension Cylinder Pressure Monitoring System	29-37
Tool Calibration	38

## Warranty:

For Warranty information visit the following URL

[www.BAND-IT-IDEX.com/Warranty.html](http://www.BAND-IT-IDEX.com/Warranty.html)

## Safety Guidelines

- Read this manual and become familiar with the tool before installing any clamps.
- Protective eyewear should be worn when connecting and disconnecting the tool to compressed air sources and during operation.
- Wear appropriate gloves for handling steel while operating this tool, applying stainless steel clamps and removing scrap clamp tail.
- Clamp tensioning can be immediately stopped by releasing the tool trigger system.
- When applying clamps, care should be taken to insure fingers and loose clothing are not in the way of the clamp being applied.
- Never attempt to clamp objects which have a potential to burst, shatter or otherwise cause bodily harm.
- Disconnect air supply and electrical power prior to maintenance and disassembly of tool components.
- Liquids or lubricants should never be put into the air lines.

The IT1000 is a pneumatic tool that needs a clean and dry air supply. The BAND-IT Air Controller Module includes a filter to meet these requirements. For proper tool performance, the air requirements at the inlet to the BAND-IT Air Controller Module of the IT1000 must be:

Item	Min	Max
Inlet Supply Pressure, PSI [kPa]	100 [690]	140 [965]
Inlet Supply Air Flow, SCFM [L/s]	1.5 [0.71]	
Particle Size In Air Supply, microns		5
Air Moisture Content		20% RH
Tension Pressure Setting, PSI [kPa]	50 [345]	80 [550]
Cut-off Pressure Setting, PSI [kPa]	100 [690]	110 [760]

**Note** – An Air Booster Unit is now available to meet air pressure requirements. Please have tool model and serial #'s available when calling the factory for service assistance. Contact BAND-IT-IDEX customer service, 303-320-4555.

**Caution** – Do not exceed a Tension pressure of 80 PSI (550 kPa). Pressures above that may cause premature clamp failure.

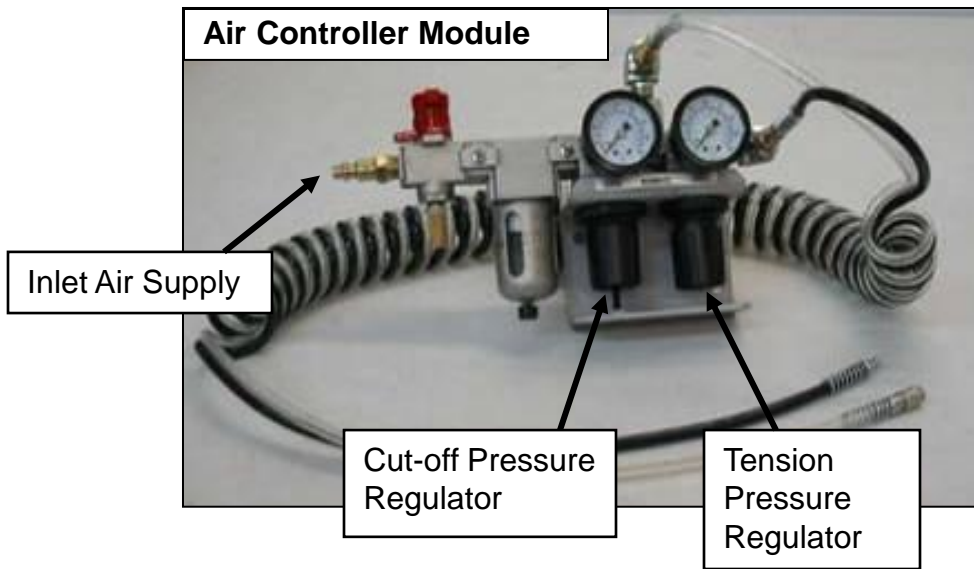

### Air Controller Module

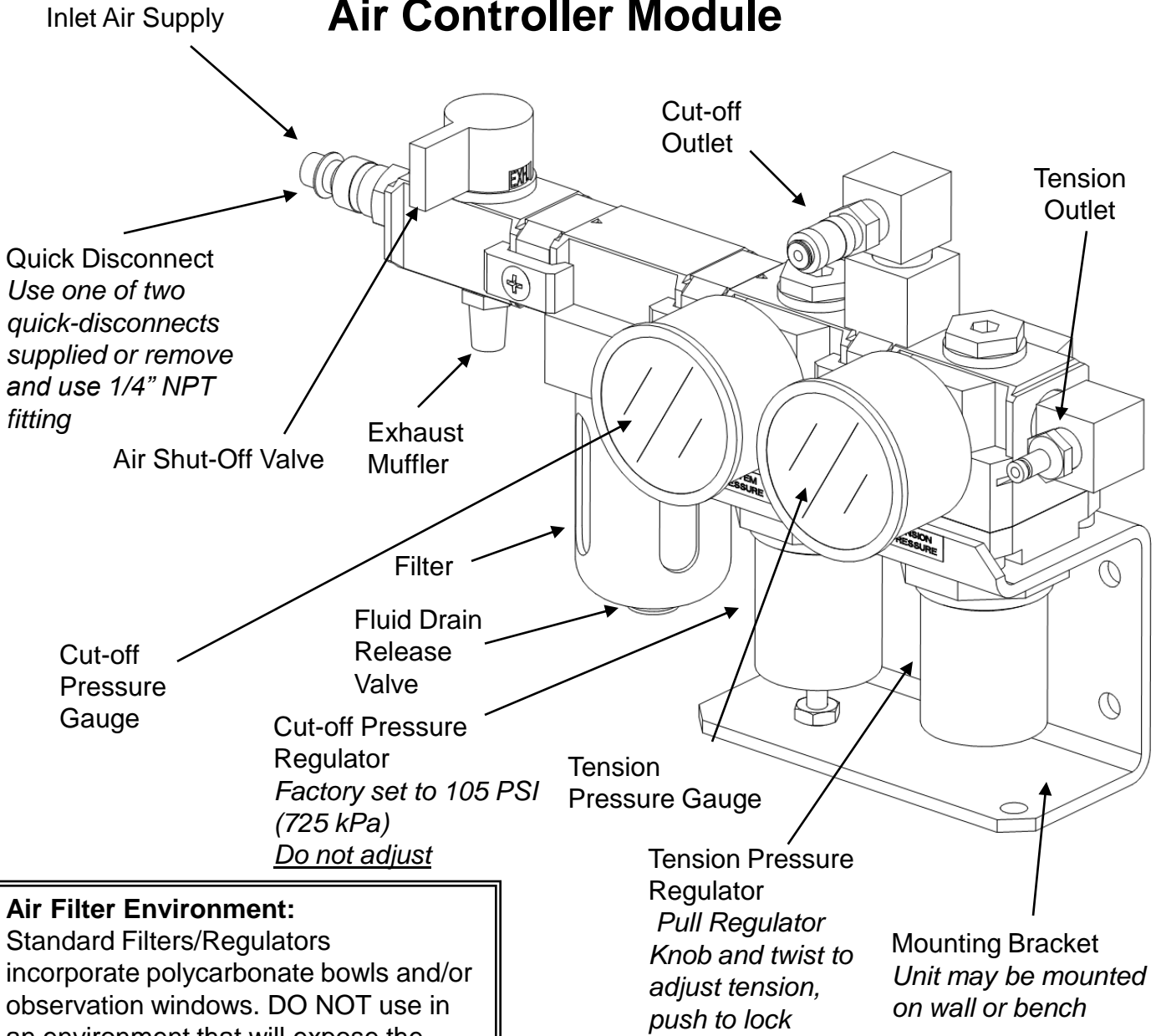

**Air Filter Environment:**  
Standard Filters/Regulators incorporate polycarbonate bowls and/or observation windows. DO NOT use in an environment that will expose the above mentioned components to synthetic fluids, organic solvents, chemicals, cutting lubricants, thread lock solutions or similar materials.

**Note:** Air Controller Module must be mounted and operated in a horizontal position.

**The standard IT1000 shipping container includes:** Air Controller Module, IT1000 tool body, coiled air line, owner's manual and tool kit. (tools with packaging option 1 include the tool and manual only)

Pressure conversion: bar = kPa / 100

### Initial Setup - Pneumatics

- Connect the tool body to the Air Controller Module using the included Coiled Hose Assembly. The hose assembly includes both a clear and black hose. Each hose end includes a female and male fitting, arranged to prevent reversing of connections.
- Connect Air Controller Module to air source (ensure air supply meets requirements on page 4) and turn RED Shut-off Valve counter clockwise to pressurize tool ("SUP" position).
- **Cut-off Pressure: 105 PSI (760 kPa) recommended.** Make sure the Cut-off Pressure Gauge located on the left side of the module reads a pressure of 100 PSI min and 110 PSI max.
- **Tension Pressure: 70 PSI (480 kPa) recommended.** The Tension Pressure Gauge monitors the tension applied to the clamp tail. Recommended air pressure at the Tension Gauge should be 50-80 PSI (345-550 kPa) for BAND-IT 1/4" Tie-Lok<sup>®</sup> Ties.
- **Caution:** Tension pressures above 80 PSI (550 kPa) may cause premature clamp failure and/or tool wear.

### Setting the Tool Air Pressure

The tension pressure directly affects the force applied to the clamp.

To correctly set the air pressure from the air controller module going to the tool, hook up the air supply to the tool. Activate the tool by depressing the trigger for a few seconds. Re-read the pressure when the tool is at rest and adjust again if necessary. Repeat until the desired pressure is shown on the tension pressure gage.

Tension pressure may need to be adjusted depending on the application.

### IT1000-AB Tool Body

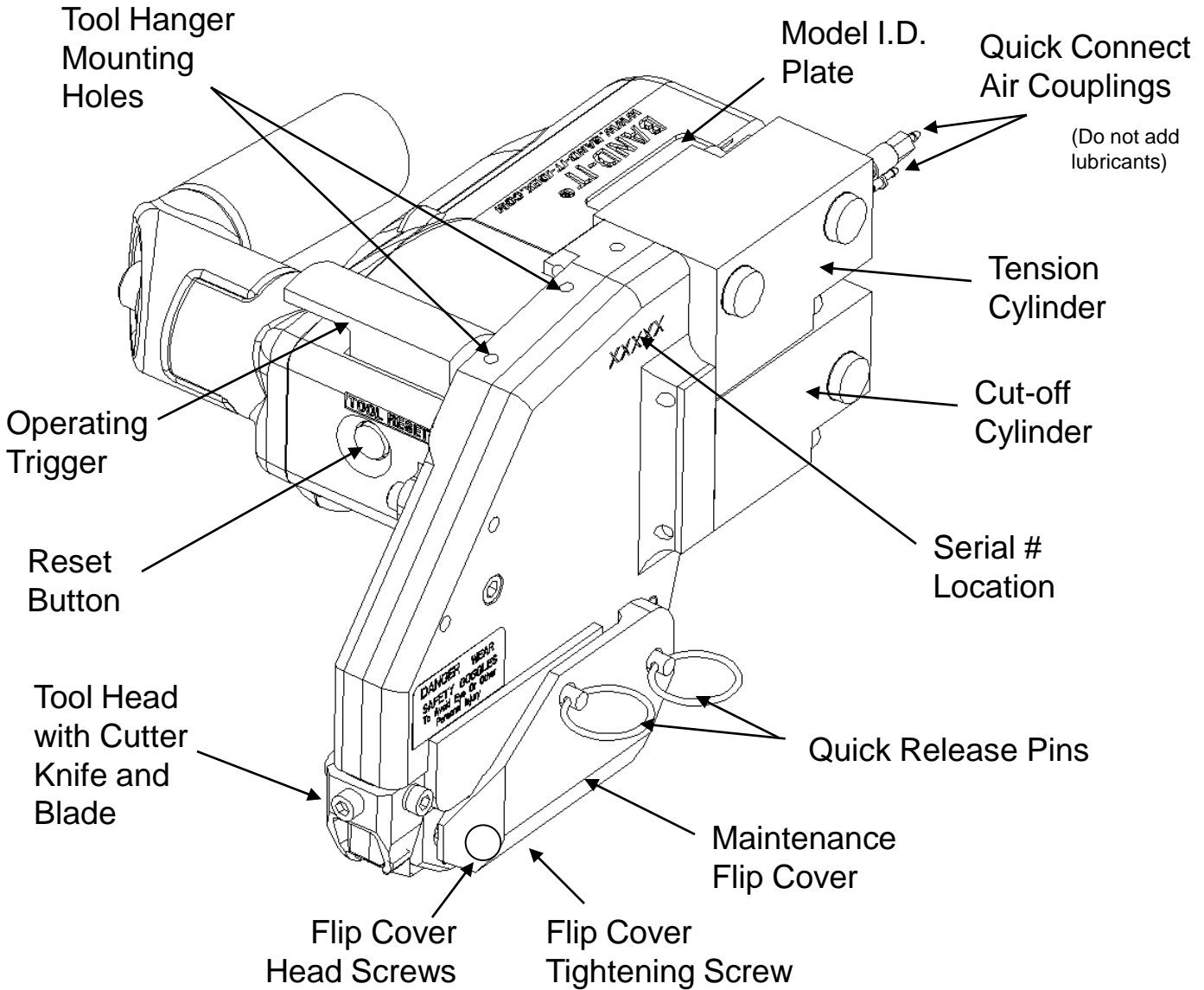

**Important:** Before disassembling tool, be sure to shut-off air supply on the Air Controller Module.

# Tool Overview



**IT1000-AB**  
**1/4" Tie-Lok® Tool**

## Pneumatic System:

The pneumatic valves and cylinders contain seals and o-ring components which can experience accelerated wear associated with the quality of the air supply. Worn cylinder o-rings allow air to bypass the pistons in the cylinders, affecting the performance of the tool and cause the output force of the tool to drift. Although cylinders are permanently lubricated, premature wear can be caused by contaminants in the air supply or the presence of water and oil. The tool's internal valves can also be affected by contaminants in the air lines causing a valve malfunction.

BAND-IT recommends the use of an Air Booster System to address the potential problems associated with low air supply. In addition to filtering and drying the air supply, it will assure pressure of 100 -110 PSI (690-760 kPa) improving the consistency of tool performance.

## Tool Function:

The IT1000 tool utilizes the conditioned air supply to actuate the mechanical linkage. The linkage activates a gripping system which tensions the Tie-Lok ties. This tension output of the tool can vary depending upon the air pressure supplied to the tool. If the pressure is increased, the output force increases.

During the tension cycle, the tool continues to tension the band until the pre-set tension is achieved. The tool stops tensioning when the pressure in the tension cylinder equals the inlet tension pressure coming from the air controller module. After the tool has achieved the preset tension, its valve switches over to the cutoff cycle. The gripping system retains force on the tie until a knife is actuated down, forming a dimple lock and cutting the excess clamp tail.



# Setup & Assembly Instructions



**IT1000-AB**  
**1/4" Tie-Lok® Tool**

## Handle adjustment:

- Using 1/4" hex key (supplied), adjust the Support Arm/Handle to ergonomically match the operator's hand.
- Be sure not to adjust the Handle too far outward (beyond interlocking legs) or the handle will not function properly or provide support to the operator.



## Hanger Mount

### Hanger Support Instructions:

1. An aluminum hanger (accessory) can be utilized for supporting the tool.
2. The hanger should be installed (as shown) into the two threaded holes.
3. Secure the hanger against the tool body with the two supplied screws.
4. A light application of vibratite is already included on the screw's thread.

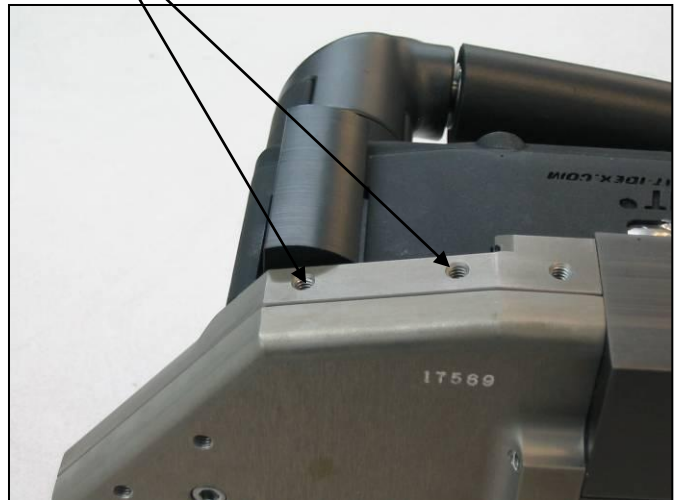

# Setup & Assembly Instructions



## IT1000-AB 1/4" Tie-Lok® Tool

### Fixture Locating Points

Three additional fixture mounting holes are available to assist with mounting the IT1000. Thread size is #10-32 for each of the holes. Usable thread depth is .400" for two of the three fixture holes. One hole is utilized to attach and lock the tool body halves together. This hole may also be used for fixturing, provided the #10-32 cap screw is replaced with a similar threaded screw with appropriate thread length secure the two halves together in addition to fixturing.

### Fixture Mounting Locations

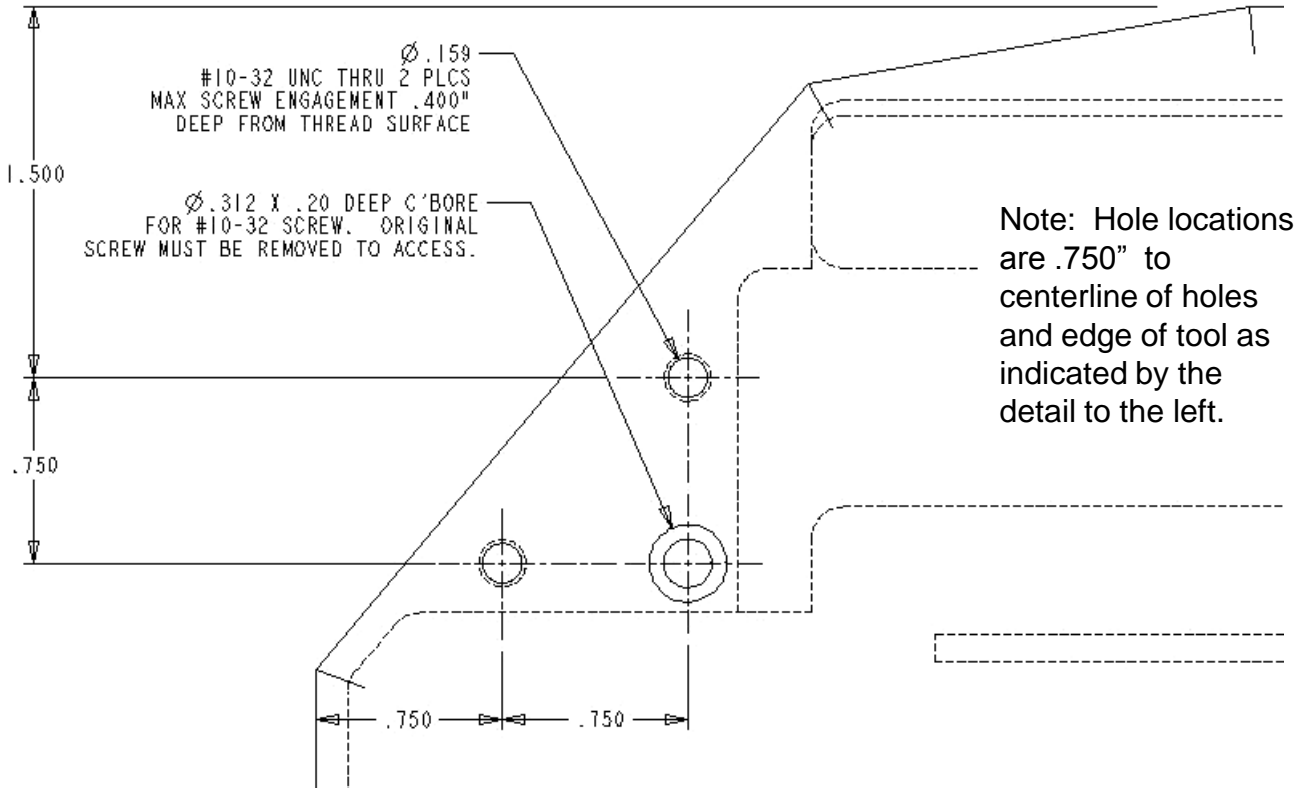
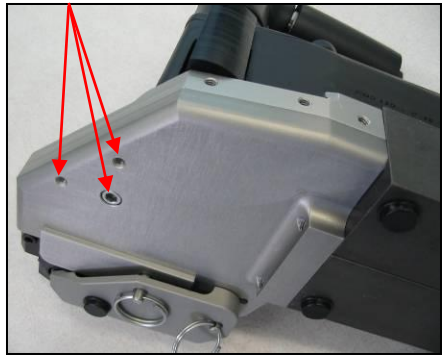

# Setup & Assembly Instructions



**IT1000-AB**  
**1/4" Tie-Lok® Tool**

Part of insuring that the tool is producing a strong lock is making sure that it approaches the application correctly and is fixtured to allow repeatability of application. The tool should approach the surface tangent to where the buckle of the band is to be applied. The tool should be allowed to float 1/8" – 1/4" above the surface to allow the buckle to move to the proper position for cut-off. Once the tool begins tensioning, the band will pull the tool down to the surface.

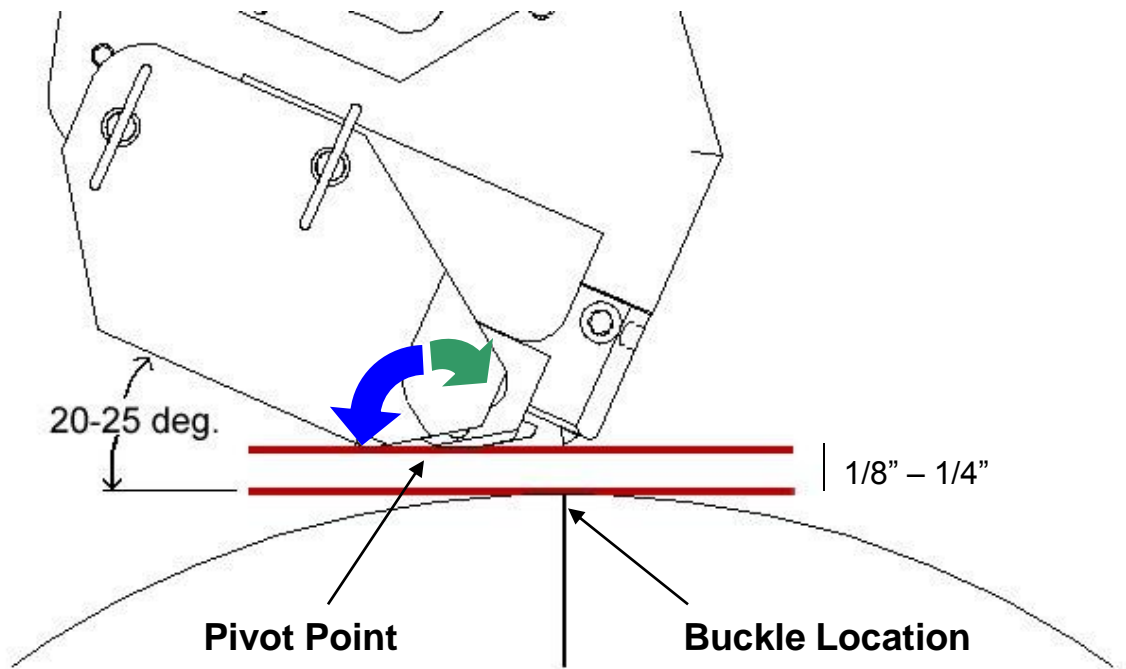

As the band is tensioning, the tool may rotate clockwise up to 5 degrees about the pivot point (Green Arrow). During the cut-off cycle, the tool must be allowed to rotate counter-clockwise up to 35 degrees (Blue Arrow). Because of this movement, **BAND-IT recommends that the tool be mounted in a fixture that will provide adequate rotation during both cycles.**

### IT1000 Orientation Requirements:

- The IT1000 tool has a number of Tool/Clamp/Object Being Clamped orientation requirements that must be followed in order to reach an acceptable end result.
- In concept, the fixture maker should attempt to replicate the natural human wrist/elbow/shoulder motions that would occur when operating the tool in the hand-held configuration, allowing the tool to float along a plane through the entire Tension (pull-up) and Cut-Off (lock) process.

### The Tool MUST:

- Contact the object being clamped without restricting or forcing.

### Suggestions Include:

- The tool fixture should be able to accommodate some longitudinal rotational movement, i.e. “wrist like”, at the final moment of applied tension. The purpose being, to allow the tool freedom of movement to orient itself in its best natural orientation as relates to the clamp and the object-being-clamped.
- A home or neutral position should be established at the optimal final position with +/- 10-12½ degrees of rotational freedom being allowed from the pivot point.
- The tool fixture should be able to accommodate some extensive movement, i.e. “elbow like”, during the tension phase to allow the tool to be “pulled” up to the object being clamped.
- Deviations from accommodating the natural inclination of the tool/clamp/object being clamped, may negatively impact the integrity of the final assembly. The clamp should fully rest upon the object being clamped at the time of final tension and cut-off. If the tool can not reach the object being clamped and attempts to cut-off, the clamp and/or lock may not form optimally.

## IT1000 Configured for Remote Actuation:

- The IT1000 with trigger option 1 is a modified version of the base unit. A tool with trigger option 0 is manually operated via the incorporated thumb actuation lever. A tool with trigger option 1 is configured to allow remote operation via palm button or other device permitting the tool to be incorporated into the customer's fixture or assembly process. Band-It offers a Foot Control Kit (I17490) for this purpose.
- The modification consists of deactivating the thumb lever actuation switch and installing two 6-ft X 1/8" O.D. hoses to accomplish the same task via the use of a remote actuation device such as a palm button or other device that can provide a pneumatic signal to pilot the tension control valve.
- Various actuation devices can be incorporated based upon end user requirements. Basic schematic for 2-way & 3-way valves included below. The valve should be set up in the normally closed mode and upon opening the circuit a supply of air is provided.
- The customer is responsible for incorporating this tool into their process, BAND-IT is available to provide advice and recommendations.

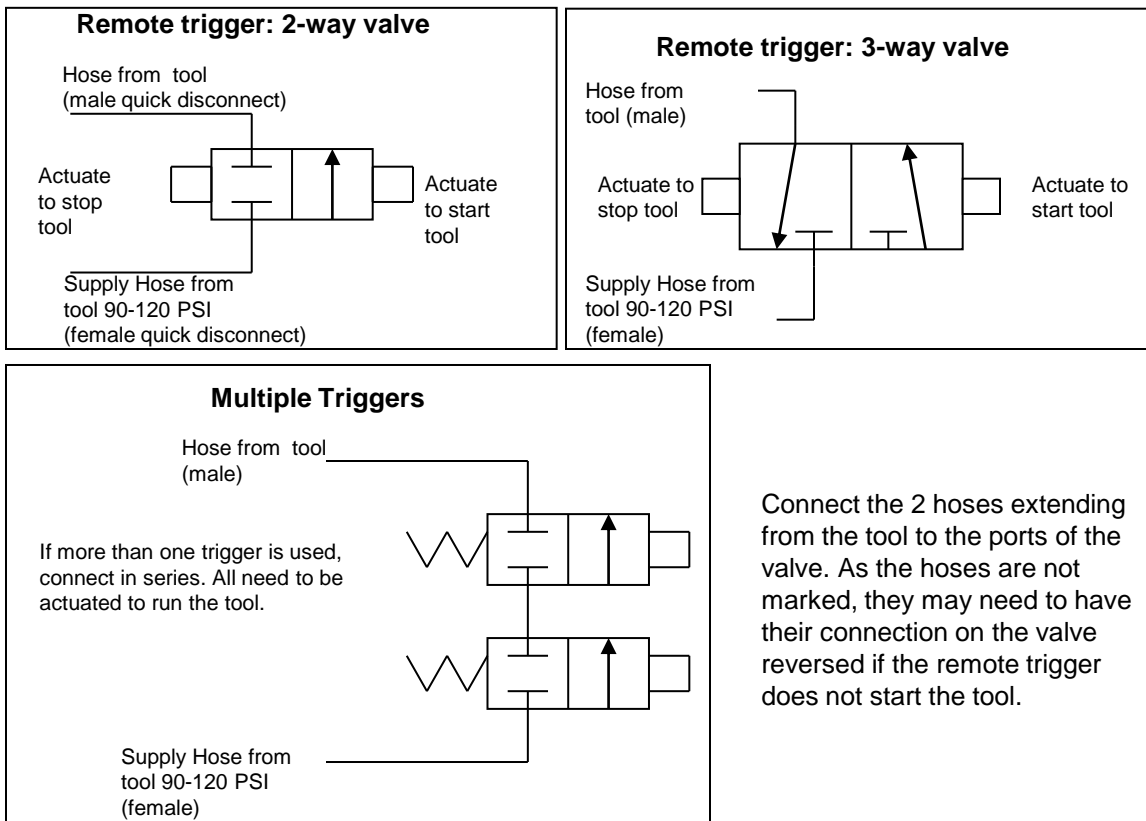

#### Tie Installation:

When installing a tie, a random visual check to verify the presence of a dimple after the tie has been applied is recommended. The dimple is the locking element of an installed band. The IT1000 forms a dimple into the band with the punch. By controlling and monitoring the items that are needed to form a good lock, an operator can help insure that the band will be applied correctly without having to inspect every assembly.

These items are:

- Adequate air pressure and volume (see **page 4,6**)
- Setting the tool air pressure (see **page 4,6**)
- Following recommended PM Schedule (see **page 21**)
- Fixture mounting the tool properly (see **page 10-13**)

#### For Best Performance and to Extend Tool Life:

- Follow preventative maintenance and parts replacement instructions (**page 21**) at appropriate service intervals.
- Do not remove factory applied lubrication from inside tool unless performing a thorough maintenance procedure and then replacing with fresh lubricant immediately.
- Do not use degreaser in the tool body.
- Do not spray any lubricant or cleaner into the Quick Connect Air Couplings.
- Use nominal recommended tension setting (listed on **page 4,6**). Higher pressure may not result in a tighter clamp, but increases the likelihood of clamp tail jamming and premature worn parts.
- Do not over-tighten Knife Pin access screws. Over torque on these screws may result in stripping screw threads.
- For maintenance beyond what is described in this manual, consult BAND-IT.

# Operating Instructions



## IT1000-AB

### 1/4" Tie-Lok® Tool

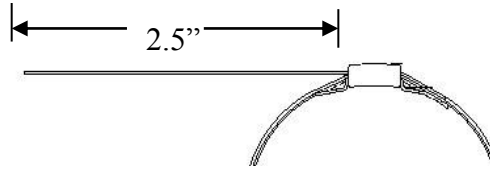
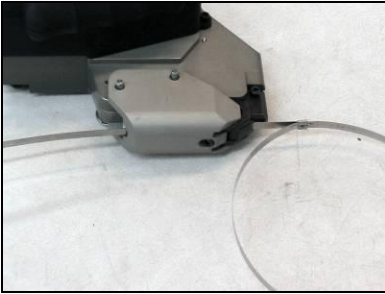

1. Insert clamp tail into tool as shown. Clamp tail length extending into tool must be at least 2.5" (6.4 cm) long. The head of the tool should rest against the buckle. **Note - Do not activate tool while inserting clamp tail. This can cause clamp tail to jam in the Tension Block Assembly.**

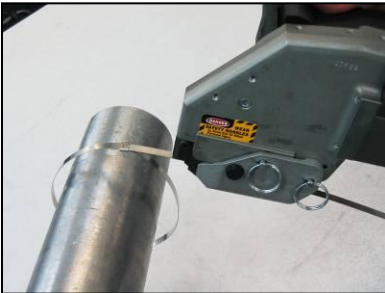

2. Begin tensioning clamp by pushing and holding down operating trigger

3. Band should be applied to a uniform solid surface allowing the buckle adequate support during the clamp locking and clamp tail cut-off operation.

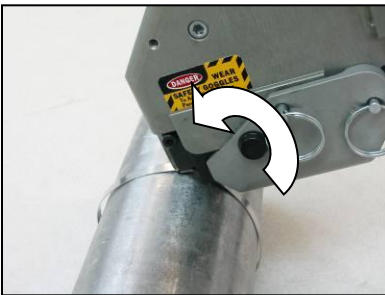

4. While tensioning clamp, hold tool slightly tipped forward. This will assist proper clamp installation. Continue to hold down operating trigger until tool completely tensions and cuts off clamp. Release trigger after cut off.



5. After clamp is completed, clamp tail scrap must be removed from tool. Clamp tail scrap is not ejected automatically. Tool is now ready for next clamp.

### Tool Fails to Fully Tension Clamp:

Failure to fully tension the clamp can be caused by a variety of factors. The two most common factors are: incorrect tension pressure and problems in the Tension Block Assembly.

- Check tension pressure setting on Tension Pressure Gauge of Air Controller Module. Adjust pressure per the settings in the **Setup & Assembly Instructions** section found on (pages 9-11).
- After air pressure settings are verified or corrected, if failure to fully tension clamps continues, evaluate the clamp tail dimple pattern. If elongated dimples are present, the problem may be with the Tension Block.

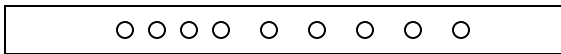

*Normal clamp tail dimple pattern.*

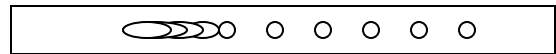

*Clamp tail dimple pattern indicates problem in the tension block assembly.*

- If a problem is indicated, follow the instructions on **page 24** to remove the tension block assembly.
- Examine the Tension Block components for excess lubrication. Refer to lubrication instructions on **pages 24, 27**.
- If dirt or debris is visible, follow the cleaning instructions on **page 24**.
- Examine the Tension Block and Gripper for wear (see below).
- If excessive wear is determined, follow the instructions on **page 24** to replace the worn parts.



### Tool fails to cut off clamp tail:

- The Inlet Air Pressure may be low. Check air supply to Air Controller Module. Cut-off Pressure Gauge should indicate 100 -110 PSI (690-760 kPa). See **pages 4-6** for air supply requirements.
  - The scrap clamp tail from the previous clamp may not have been removed. Press the Reset Button to release the tension on the clamp and remove the scrap clamp tail.
  - The Cutter Blade or Knife may be worn. See below for Cutter Blade inspection and replacement.
- **Note:** The Flip Cover Tightening Screw and Head Screws are factory tensioned and will need to have thread locking compound reapplied and be re-tightened after the quick release pins are reinstalled upon completion of maintenance.

### Cutter Blade Inspection and Replacement:



1. Loosen the Flip Cover Tightening Screw and Head Screws (**see note above**) to remove both Quick Release Pins as shown.

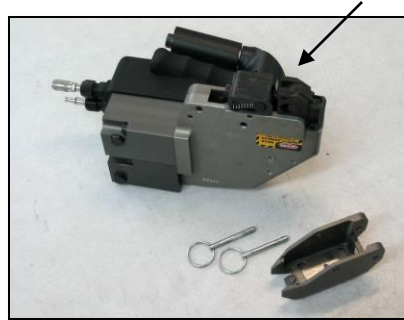

2. Remove Flip Cover and Tension Block Assembly for cleaning and lubrication.



3. Remove the Cutter Blade Pin and Cutter Blade. The Cutter Blade has two working edges and can be rotated 180° to use the second edge prior to replacement.

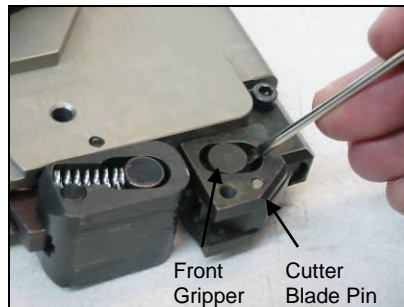

4. When installing the Cutter Blade Pin, use a small screwdriver to push the front gripper toward the back of the tool.

# Troubleshooting Matrix



## IT1000-AB

### 1/4" Tie-Lok® Tool

Symptom	Probable cause	Recommended Fix	Page
Tool will not tension properly (i.e. slipping, slow etc.)	Rear tension block slipping, therefore tool does not reach cut off tension.	Remove and inspect gripper block assembly. Replace as required.	24
	Front gripper slipping	Remove and inspect front gripper and gripper guide arm. Replace if worn.	*
	Dirty front and rear gripper interfaces	Remove and clean surfaces surrounding the grippers.	24
	Air leaks when trigger is not activated	Listen for air leaks. Check red valve , Air lines, and replace as required. No air leaks allowed. Remove and replace as required or contact BAND-IT.	28
	Worn flip cover and tool body	Inspect inside of flip cover and bottom of tool body for excessive wear. Replace flip cover as required. For tool body wear contact BAND-IT for evaluation.	28
	Water or oil in pneumatic lines.	Purge pneumatic lines and red four way valve assembly. Install a desiccant air dryer or similar which meets tool set up requirements).	*
	Tool cutting before full tension applied.	Verify cut-off timing. If required, remove handle cover and adjust timing valve. Replace if damaged.	28
Tool will not cut off clamp tail	Premature release of trigger	Hold trigger down until tool completes cut off cycle	15
	Fluctuating facility air pressure	Verify if facility air pressure meets tool set up requirements. Air booster system may be required.	4-8
	Worn knife/blade	Remove and replace knife and blade. Refer to maintenance schedule.	21,22
	Timing valve adjustment	Verify timing. If required, remove right side body and adjust timing valve. Replace if damaged.	28
	Rear tension block slipping, therefore tool does not reach cut off tension.	Remove and inspect gripper block assembly. Replace as required.	24
	Coiled hose line has air leak	Verify no air leaks in coiled hose assembly. Remove and replace as required.	4-8
	Front gripper slipping	Remove and inspect front gripper and gripper guide arm. Replace if worn.	*
	Red four way valve malfunction	Remove clean and inspect. Replace as required.	*
	Worn blade pin or housing	Remove and replace blade pin and/or Maintenance Flip Cover.	23

# Troubleshooting Matrix



## IT1000-AB

### 1/4" Tie-Lok® Tool

Symptom	Probable cause	Recommended Fix	Page
Tool will not cut off clamp tail - Continued.	Linkage components damaged, causing interference	Remove tool left side body and verify linkage mechanism. Remove and replace damage as required or contact BAND-IT.	27
	Cut-off cylinder seal damaged or leaking	Remove left side tool body and verify seal integrity	*
	Cut off pneumatic air leak	Verify Coiled Hose Assembly is free of air leaks. Remove handle cover and inspect for leaks on gray anodized valve assembly and red valve assembly. Inspect for leaks in pneumatic system.	*
	Water or oil in pneumatic lines.	Purge pneumatic lines and red four way valve assembly. Install a desiccant air dryer or similar equipment which meets tool requirements (see manual).	4
	Screws holding Cutter Knife Pin too long or loose	Verify proper length screws and Cutter Knife Pin seated properly.	23
	Coiled hose line is reversed (i.e. cut off pressure is actually going to tension cylinder.	Verify coiled hose air line from right side of control module enters bottom fitting on tool.	4,5,7
Loose clamp after cut-off	Improper tool use	Verify operator properly trained and familiar with tool manual.	5,7,8,14
	Tension setting too low	Adjust Air Controller Module's tension setting per instructions.	4
	Improper buckle location or application	Locate buckle on smallest radius area. Buckle must be supported underneath during application. Contact BAND-IT for application verification / recommendation.	15
	Tool cuts clamp tail before reaching full tension.	Verify timing. If required remove right side handle and adjust Timing Valve. Replace if damaged.	28
	Worn Cutter Knife/ Cutter Blade	Remove and replace Cutter Knife and Cutter Blade. Refer to maintenance schedule.	17
	Air leaks when trigger is not activated	Listen for air leaks. Check red valve, Air lines, and replace as required. No air leaks allowed. Remove and replace as required or contact BAND-IT.	Contact BAND-IT for assistance
Tool will not operate when trigger is depressed	Control Module air pressure valve is in "off" position.	Rotate Control Module valve to open position. Verify gauges read air pressure.	5
	Pinched coil hose line	Loosen fitting on coiled hose assembly where it enters tool body.	4,7
	Kinked or pinched air line	Remove right side handle and inspect air lines. Remove and replace as required.	28
	Tension piston interference with hanger screw holes.	Loosen Hanger Screw on top of tool. Thread engagement cannot exceed .125 in.	11
	Quick disconnect fittings not positively engaged.	Disconnect and firmly reconnect.	5,8

Symptom	Probable cause	Recommended Fix	Page
Clamp will not insert into tool	Control Module air pressure valve is in "off" position.	Rotate Control Module shut-off valve to open position. Verify gauges, air pressure and all connections.	5
	Clamp tail inside tool	Remove clamp tail, if jammed remove maintenance/flip cover and remove clamp material.	15-17
	Knife is in down position.	Remove or replace knife. Verify missing and or damaged linkage.	23
	Wrong clamp type for tool	Verify proper tool for selected clamp.	Cover page
Handle will not adjust	Handle nut is damaged/misaligned.	Remove handle assembly and inspect nut/housing for damage. Replace as required.	9

\* = for additional assistance, contact BAND-IT

**Tool Preventative Maintenance:**

The tool has some wear components that must be checked and replaced on a certain schedule. BAND-IT has developed a Preventative Maintenance (PM) schedule to help facilitate these requirements. If tools are experiencing difficulties during function or there audible air leaks coming from inside the handle, the tool should be returned to BAND-IT-IDEX, Inc. for servicing.

BAND-IT recommends that the tool be sent in for general overhaul every 100,000 clamps installed.

**Preventative Maintenance Schedule**

<b>Clamps Installed</b>	<b>Maintenance Item</b>	<b>Maintenance Action</b>
Every 12,500	Tension Block Assembly	Clean & Re-Lubricate
	Flip Cover	Clean & Re-Lubricate
Every 25,000	Mechanical Linkage	Clean & Re-Lubricate
	Tool Head	Clean & Re-Lubricate
	Cut-off Blade	Rotate
	Cut-off Knife	Rotate
	Front Gripper	Clean & Re-Lubricate
Every 50,000	Blade, Blade pin, Knife and Knife pin	Replace
	Tension Block Assembly	Replace Assembly
	Front Gripper	Replace Gripper

Production tools will experience wear of specific parts. Preventative maintenance, including regular cleaning and lubrication, will reduce the replacement frequency of these parts. To maximize life, use synthetic gel lubricant containing Teflon. See **(pages 22-28)** for tool maintenance. When repairing tools, threaded fasteners should be secured using a small amount of Loctite, Blue - Medium strength being careful to apply sparingly.

<b>Part #</b>	<b>*Replacement Parts Description</b>	<b>Quantity per Tool</b>
I10688	Knife	1
I13887	Knife Pin	1
I13687	Knife Pin Access Screw	3
I10788	Blade	1
I13987	Blade Pin	1
I10188	Tension Block	1
I10190	Tension Block Assembly (Includes I10188, I10388, I10888, and 2 x A38487)	1
I24199	Flip Cover Assembly (Includes assembled flip cover and 2 quick release pins)	1
I16387	Lubricant (synthetic gel lubricant containing Teflon)	

**\*Note** – A basic IT1000 Repair Parts Kit is now available.

Please have tool model and serial #'s available when calling the factory for service assistance. Contact BAND-IT-IDEX customer service, 800-525-0758.

Part numbers are subject to change.

#### Knife Assembly Replacement:

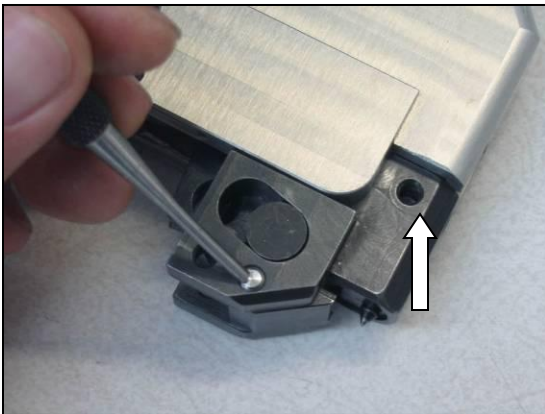

A) Remove Cutter Blade as described on **page 17**.

B) Remove the 3 Knife Pin Access Screws. These are special length screws. Remove dimple clip.

**Important:** When repairing tools, threaded fasteners should be secured using Loctite, Blue - Medium strength.

To remove Cutter Knife Pin the Knife Assembly must be in its uppermost position indicated by the Cutter Knife Pin in line with the access hole. If not aligned, connect the tool to the Air Controller Module. Open the Air Shut-off Valve to momentarily pressurize the tool. Close the valve and disconnect the tool from the Air Controller Module. Then push out the Cutter Knife Pin with a piece of wire (for example, a bent paper clip).

Once the pin is removed, grasp the Knife Assembly with a pair of needle-nose pliers and pull out of tool head. Examine for wear and replace if needed.

Re-install all parts in reverse order. After the Maintenance Flip Cover is installed and Quick Release Pins are in place, apply tension to the Flip Cover Screw and Head Screws.

### Tension Block Assembly Maintenance:

Remove the Maintenance Flip Cover by loosening the Maintenance Cover Tightening Screw and Head Screws on the Maintenance Flip Cover and removing both Quick Release Pins as shown on **page 17**.

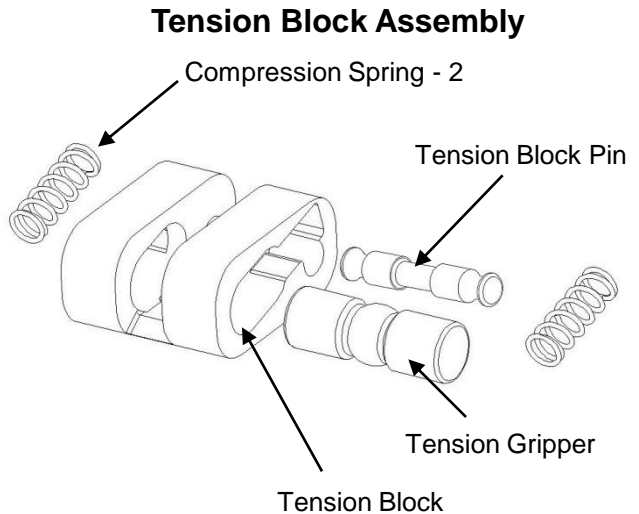
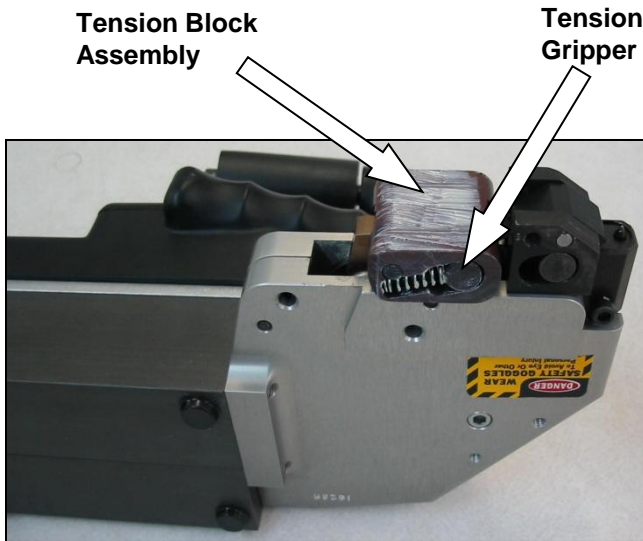

### Tension Block Assembly, inspection and parts replacement:

#### Disassembly:

- Lift and remove the Tension Block Assembly from the notch on the Tension Arm.
- Push out the Gripper. remove the loose Gripper Springs.
- Push out the Gripper Pin.

#### Inspection:

- Inspect and replace the Tension Block if worn.
- Inspect and replace the Tension Gripper if worn.
- Inspect and replace the Gripper Pin if worn.

#### Reassembly:

- Lubricate the Gripper surfaces as shown on **page 27**.
- Install the Gripper in the Tension Block.
- Lubricate the Tension Pin surfaces as shown on **page 27**.
- Install the Gripper Pin in the Tension Block.
- Reinstall the Gripper Springs.
- Reinstall the Tension Block Assembly. Be careful to engage the Tension Block Pin with the notch on the Tension Arm.
- Lubricate the Maintenance Flip Cover as described on **page 27**.
- Reinstall the Maintenance Flip Cover and insert Quick Release Pins.
- Tension the Flip Cover Tightening Screw and Head Screws to complete reassembly.

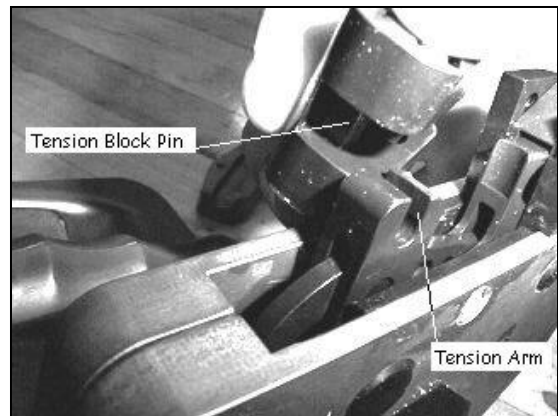



- Remove the Maintenance Flip Cover. Examine all moving parts and linkages for wear.
- Using an air nozzle, gently clean the parts of any dirt and metal filings in the tensioning cavity.
- Using cotton swabs or a short bristled brush, continue to wipe away any foreign debris and purge once again with the air nozzle.
- After thoroughly cleaning all moving parts, re-lubricate all surfaces. Following are lubrication instructions.
- For mechanical parts lubrication use a synthetic gel lubricant containing Teflon.

### Procedure for disassembly to clean and lubricate the mechanical linkage points

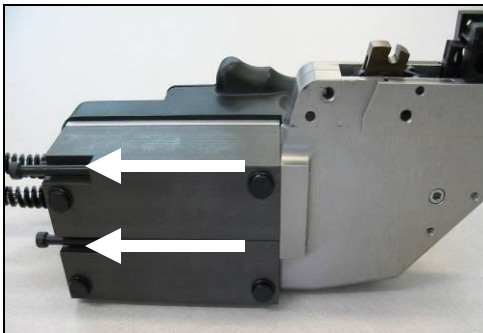

- 1) Remove the two screws located at the back of the cylinders. Remove third screw holding the side bodies together. Holding the tool in place, gently lift the side cover exposing the mechanical linkage. This side cover is a close fit and may require a slight rocking motion to separate the cover from the tool.

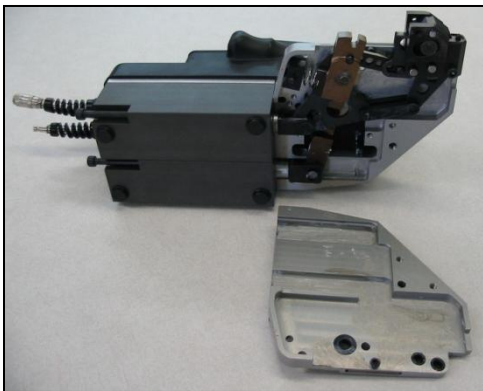

- 2) Examine the linkage for over-all condition such as dirt, metal filings, liquid contamination and lubrication.
- 3) Examine the upper cylinder (tension cylinder), for evidence of air leaks, noted by residue around the piston.
- 4) Clean tool cavity, including tool body, linkage, and already removed tool cover.

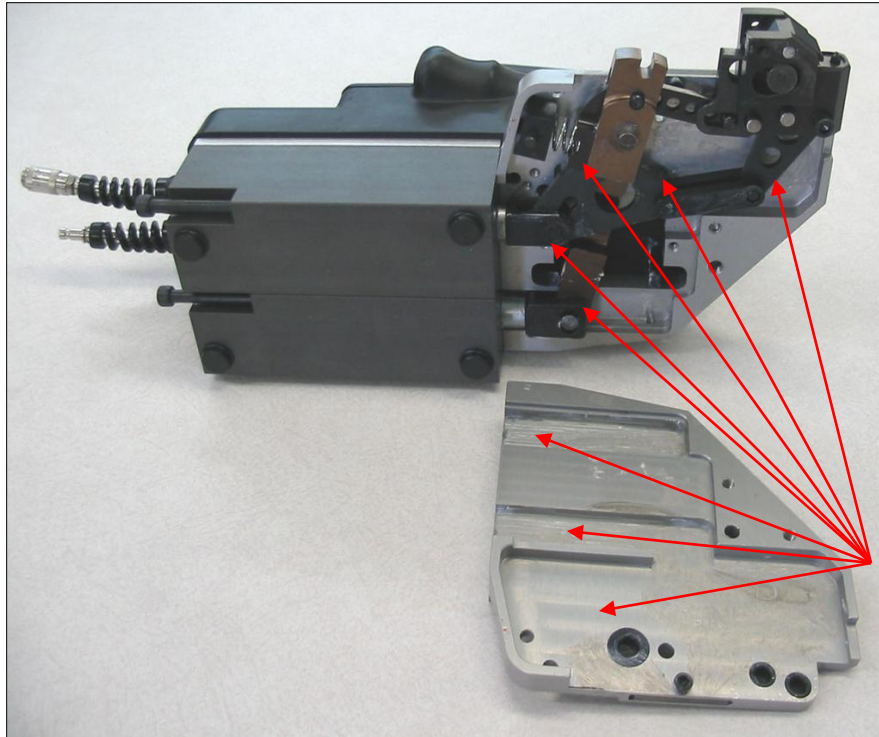

- 5) Lubricate the removed cover as shown with red arrows above. Also, lubricate the tool body, linkage and Tension Block Assembly as shown on **page 27**.
- 6) Inspect all mechanical linkage for lubrication, proper placement and re-fit cover.
- 7) Secure the tool side cover by inserting and tensioning (2) #10 – 32 X 4" length cap screws through the Cylinder Housing and into the Cover. Apply a light dab of Blue-Medium Loctite to one or two threads to prevent loosening during operation.

**Lubrication** – Follow recommended intervals – Use a synthetic gel lubricant containing Teflon for the internal parts as shown and described. Lubricate all pivot points and internal surfaces of maintenance flip cover with a light coating of the lubricant.

**Caution** – Excessive amounts of lubricant may result in gripper slippage, requiring a full repeat of cleaning process.

*Lightly lubricate all points indicated with red arrows.*

Maintenance Flip Cover every 12,500 cycles

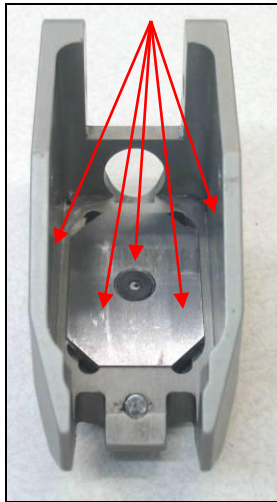

Tool mechanics every 25,000 cycles

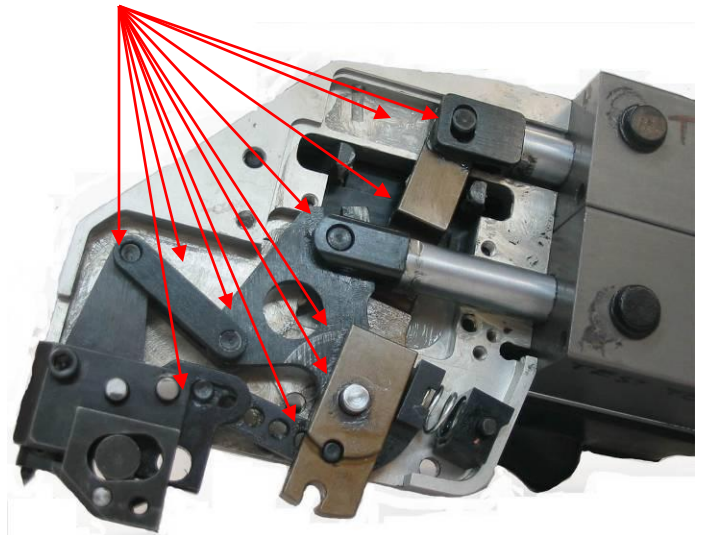

After the Maintenance Flip Cover is cleaned, lubricated, installed and Quick Release Pins are in place, apply tension to the Flip Cover Screw and Head Screws. Refer to **pages 7, 17.**

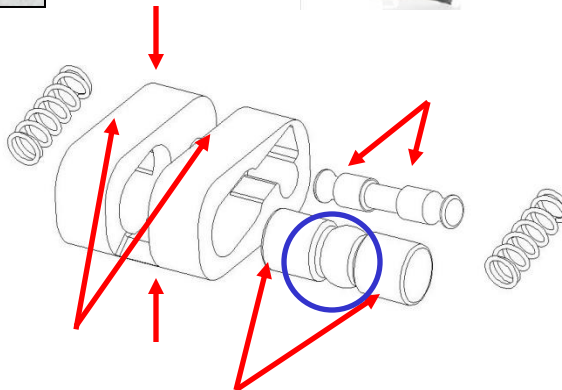

Tension Block Assembly every 12,500 cycles

Note: Ensure no lubrication is present in the center of Gripper. (indicated by the **blue circle**)

### Procedure to adjust the timing of the clamp tail cut-off:



The Timing Valve will be affected over time by contaminants in the air system. Moisture, dirt particles, oil and solvents can cause blockage or fluctuations in the tool performance.

Cycle should be .5 – 1.0 seconds.

Cut-off timing set too short will not allow the clamp to achieve the desired tension before switching to the cut-off function causing a loose clamp. Clamping on softer objects requires a longer timing.

Cut-off timing set too long may slow production and cause operator to twist the tool during application. This may damage tool.

### Procedure:

- 1) Remove the two cap screws in the Handle Cover with a 9/64" hex key. Remove cover and lay aside. The Brass Needle Valve used to adjust timing is highlighted in view to the left.
- 2) To adjust: Hold the valve in position being careful not to kink tubing inside tool. Start by gently turning the Adjusting Valve Screw clockwise until snug. Back out the Adjusting Screw counterclockwise 1 1/2 turns. This should be the proper setting, yielding a .5-1.0 second delay.
- 3) To test and verify proper adjustment: Connect the tool to the Air Control Module, then turn supply valve on. Gently kink the coiled air supply tube connected to the bottom Quick Connect Air Coupling (top photo), then activate the Tool Trigger. This action causes the tool to cut off, allowing the timing to be reviewed. Adjusting the Timing Screw in by 1/2 turn will slow the tool's cut-off action. Adjusting the Timing Screw out by a half turn increases the speed of the cut-off activation. Repeat this entire step until timing is set at a .5 – 1.0 second delay. **Caution: Setting timing to less than .5 may result in loose clamps.**

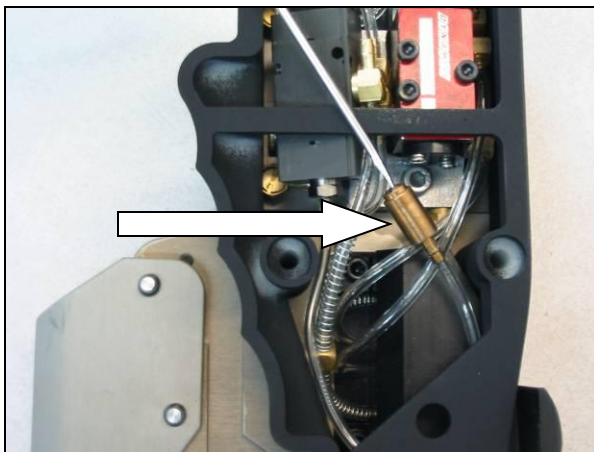
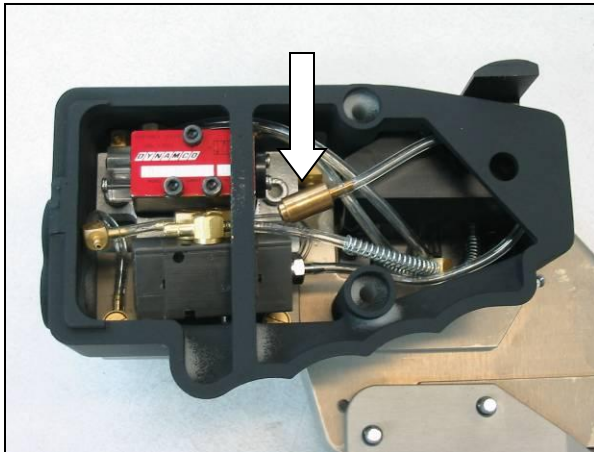

# Tension Cylinder Pressure Monitoring System



## IT1000-AB 1/4" Tie-Lok® Tool

The tension feedback system provides an indication, but not confirmation, of clamp tail tension by transmitting a pressure reading from the tension cylinder via a pressure transducer. The cut-off cylinder begins to move when the tool has reached maximum tension. The force applied by the tension cylinder is calculated from the transducer signal. The transducer signal is recorded when the cut-off cylinder begins to move. The system also provides a gateway to pass the number of completed cycles of both the tension and cutoff cylinders to the data collection device. Data, in ASCII format, is sent via an RS-232 serial port to a data collection device (not part of the system).

The tension feedback system consists of:

- (1) Data Control Box
- (2) 5VDC Power Supply with interchangeable outlet clips  
(US, UK and Europe)
- (3) RS232 Serial Cable, approx. 10 ft length
- (4) 15 foot Data Cable
- (5) CD with programs and this manual
- (6) Tool with other option 1

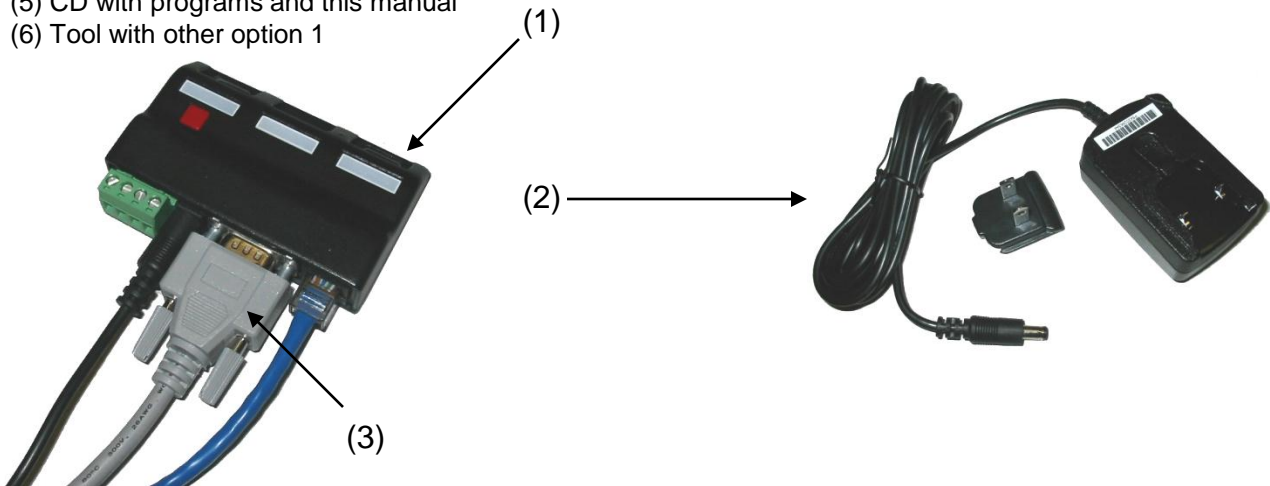

### Initial Set Up:

- Connect the serial cable from the data control box to the data collection device, (e.g. Computer)
- Set the BAUD selection switch on the back of the control box to the desired communication speed: 2400 or 9600.
- Connect the data cable to the receptacles on both the tool and control box.
- If desired, one or both of the relay contact sets can be connected to a customer supplied device. For example, these can be used to send signals to a PLC, or control a tool shutoff device.
- Plug the 5VDC power supply into a 110-240VAC 50-60Hz wall outlet and the cable to the power connector on the Control Box.
- The green indicator on the control box should be lit indicating the system is ready to monitor the tension pressure.
- If the yellow indicator is lit this indicates the tool has not been detected. Insure the data cable is connected and routed away from sources of electrical noise.
- For information on data capture, refer to **page 31**.
- To verify tool cut-off timing, refer to **pages 28, 33**.

**Overview of Data Control Box**

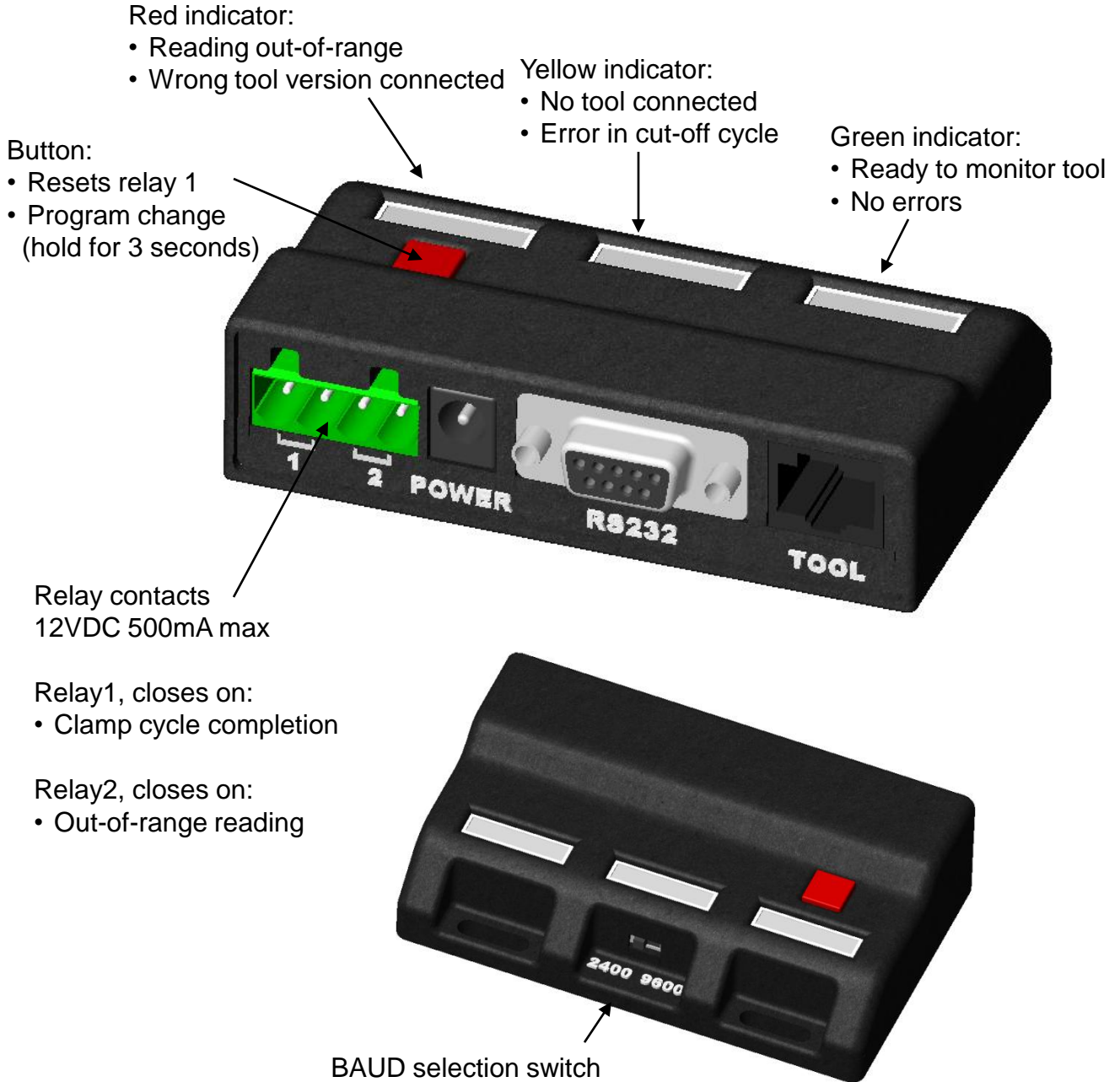

## Setting the upper and lower control limits

Included in the CD provided with the tool is a program that can be used to adjust the type of data and the upper and lower control limits that the control box will monitor.

1. Connect the control box to power and to a device that will allow 2-way RS232 communication, such as a PC with HyperTerminal. For this procedure flow control must be disabled.
2. On the CD, locate and run the file named "Control Settings.exe"
3. Press the Download button. This will load a program into the control box.
4. Open the HyperTerminal and follow the instructions. If the option to check both pressure and force is selected, use caution in setting the limits. Both the force and pressure ranges must be met to keep from generating an error message, so it is possible to create a situation where the error state will never clear.
5. Once the limits have been set, close HyperTerminal and locate and run the file named "I75301.exe" located on the CD. Press Download and the operating program will be re-installed.
6. The data control box is now ready for use.
7. Example:

Program: I75302 Rev A

This program will reset the limits on the Data Control Box

Enter the units of force to use: LBF (L), or Newton (N): **L**

Enter the units of pressure to use: psi (P) or kPa (A): **P**

Enter data type to check: PSI (p), Force (f), or Both (b): **F**

Enter the lower force limit: **300**

Enter the upper force limit: **360**

Force: 300 to 360 LBF

If this is correct, download the operating program.

If not, try again.

## Suggestions for choosing the control limits:

All control boxes arrive from the factory pre-set to check the pressure range stated in this manual.

As the pressure to force relationship changes from tool to tool, it is recommended that the force be the limiting factor. Keep in mind that the force range required will vary depending on the clamping application. Run test samples at different settings to determine the upper and lower limits acceptable for the application.

**Specifications:**

- Power: 110-240 50-60 Hz VAC input, 5VDC output wall supply adapter (6 ft wire provided)
- Pressure range: will detect 10 to 125 PSI (70-860 kPa)
- Output: 9-pin RS-232 serial (approx 10 ft cable provided)
- Serial settings:
  - o 2400 or 9600 Baud
  - o 8 bit
  - o No parity
  - o 1 stop bit
  - o ASCII formatted data
  - o No flow control
- Data format: Data columns (clamp number, PSI, estimated LBF and error if any) separated by tabs, each record separated by line feed / carriage return, (hard return)
- Actual ASCII output: items in [ ] are output only if an error is detected:  
(cycle number) 9 (Pressure) 9 (Force) 9 (serial number) [9 (error)] 10 13
- Data is sent at each clamp installation cycle
- Accuracy:
  - o PSI: +/- 1.0 kPa: +/- 7
  - o LBF: +/- 10 N: +/- 45

**Operation:**

- When the system calculates a force or pressure outside the predetermined range the red light will be lit, error message will be appended to output data string, and the contacts of relay-1 will close. This condition could be caused by: tension pressure set incorrectly, an air leak in the tool, cut-off timing set too short, or low air supply volume to the tool.
- Correct the problems as required and cycle the tool by installing a clamp or using the M28090 device. If the red indicator is still lit, continue to look for and correct problems related to the air system.
- Note: Pushing the button on the control box will clear the error, return the indicator to green, and open the relay contacts. This is not normally needed, unless the relay directly controls a shutoff device to the tool. See **page 34** for additional means to reset the system.
- When the Control box first detects a connected tool, it will output the tool information: Total number of cycles and tool serial number.



**Data Capture:**

- The tension feedback system can be used with many data capturing devices including any computer with Windows operating software.
- Any properly equipped tool will work with any I75390 data control box. The tool's serial #, clamp count and settings remain with the tool and will be detected by any control box used. (\*the I75390 system will not work with the X75390 system)
- Any software or hardware that can read the stated format can be used to collect data as it is sent from the tool.
- Updates or customizations to the program in the control box can be sent to the customer using a single executable file, no other software is required.  
Contact BAND-IT Engineering at 800-525-0758.

**Example of Data Output:**

Program: I75301 Rev A

Pressure: 55 to 75

Force: 336 to 360

Clamp #	PSI	LBF	Tool #	Error
30			11111	
31	69.1	360	11111	
32	64.8	337	11111	
33	58.1	302	11111	LOW
34	72.7	378	11111	HIGH
35	69.0	359	11111	C

- LBF = The calculated force applied to the clamp tail +/- 10 LBF.
- One or both of the Pressure and Force rows will display, depending on control box settings. See page XX for instructions on setting the parameters.
- Clamp number 33 shows a low output and clamp number 34 shows a high output for this example.
- Clamp number 35 shows the data output when the system fails to detect a complete cutoff cycle in the time allowed. Note that having the tool on the M28090 device will trigger this error.
- Clamp number 30 shows output when tool is first connected.

**Incompatible tools:**

- In the case that the tool does not have the correct hardware installed the data control box will output the message "Error! Incompatible tool type detected"
- Contact BAND-IT for information on upgrades.

**Trouble Shooting Guide for the Tension Feedback System:**

No data output: Is power connected? Is the tool connected with a CAT5 patch cable? Is the control box connected using a RS-232 serial cable? Null modem cables will NOT work with this device. Some computer systems' ports, to which the control box is connected, may be in use by another program. Close the program or try another port.

Data output is garbled: Check the settings on the data capture device and control box. Maximum cable length can be 25 feet between control box and tool, maximum cable length between the breakout box and data capture location can be 50 feet. (For longer serial cable run, we suggest the use of a serial line amplifier).

Tool cycles, but no tool data is output: If the breakout box sends the header strings, but not tool pressure and force data, *make sure the air lines inside tool handle are not pinched.* This can be verified by loosening the two handle screws and re-cycling the tool. Verify timing is properly adjusted, refer to page 28. Verify the cable connections and settings are correct and the tool is operating at correct tension cylinder pressure.

Tool cycles and system reads normal but clamp is loose:

Refer to this manual. See air pressure settings, cleaning, lubrication, preventative maintenance, parts replacement sections. Tool user is responsible for ensuring clamp application.

Box randomly resets and/or occasionally fails to send data:

Caused by interference from outside sources. Move the box away from devices like power converters and motors. If this is not possible the box can be placed inside its own shielded/grounded enclosure.

**Cut-off Timing Verification Procedure**

1. This procedure requires the use of the M28090 Calibration Device.
2. Prepare tool by connecting the M28090 Calibration Device per instructions included with the device.
3. To switch the breakout box over to check cut-off timing, press and hold the button on the control box 3-4 seconds. The green indicator will begin flashing and the display will read **"Ready to check timing: Press Trigger"**
4. Press the trigger on the Tool. The control box will output the measured cut-off timing.  
Examples:  
"Timing OK, Time = 1.01 sec"  
"Timing Error! Timing short = .80 sec"
5. The green indicator will light and remain solid if the timing is well within the suggested range. The Red indicator will light if the timing cycle is set too short or too long. Follow instructions on **page 28** for adjustments and re-check.
6. Press the reset button on the tool and the control box will reset, flashing the green indicator and be ready to check the timing again.
7. To switch from timing check mode to normal program operation, press and hold the reset button on the breakout box for 3-4 seconds.

**Note:** The program will not switch into or out of timing mode unless it detects an attached tool.

**Connections:**

**1. Data cable connection between tool and breakout box:**

8-pin, 15 ft long, CAT5e cable provided. This cable carries 5 VDC power and 5 digital lines. Using a cable longer than 15 ft will degrade the signal and may cause the tool to incorrectly report pressure readings.

Only connect the data control box to the tool. *Never* connect either the tool or control box to any other device. Damage may occur to device, control box, and/or tool.

Before connecting the cable to the tool and control box, check for debris inside both connectors. On rare occasions, debris inside the connectors will cause a short, possibly damaging the electronics.

**2. Serial connection:**

9-pin, approx 10 ft long, straight RS232 serial cable provided. *Do not* use a null modem cable. (pins 1, and 6 thru 9 are inactive)

Pin 2: Data is sent on this pin in ASCII format

Pin 3: Not needed for normal operation. This pin is used to reprogram the control box and needs to be connected for program updates.

Pin 4: This pin controls the control box reset and programming. Changing the state of the this pin from low to high will force a reset on the control box. If needed, this can be used to clear errors.

See Figure for Pin Assignments:

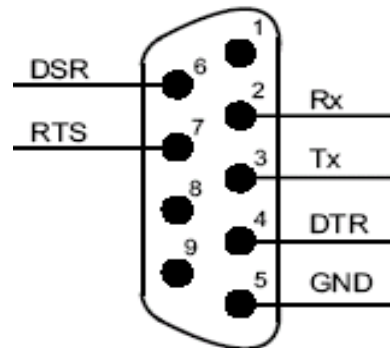

**3. Relay contacts:**

Two sets of normally open relay contacts. Each set can handle up to 12VDC 500mA of power.

To connect to the contacts, use the provided screw terminal block.

(Example of data collection using a Windows XP Operating System)

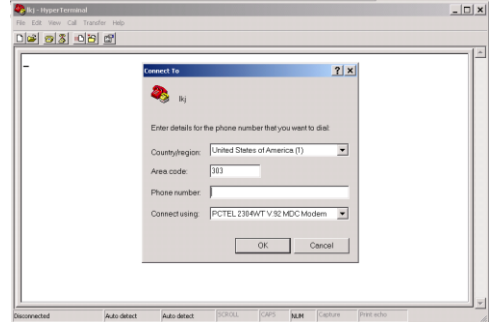
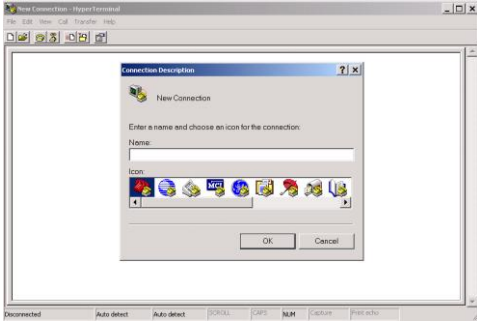

1. Begin with Start Menu:\Programs\  
Accessories\Communications\HyperTerminal
2. Type a connection name.
3. Click OK

4. "Connect to" dialog box appears
5. In the "Connect Using" text box,  
choose COM1, Click OK

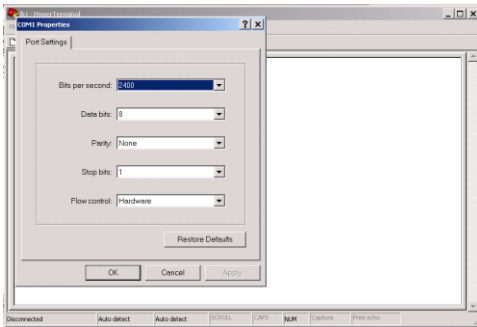

6. Properties dialog box appears
7. Port Settings should be:
  - Bits per second (2400 or 9600)
  - Data bits (8)
  - Parity (None)
  - Stop bits (1)
  - Flow control (NONE)

8. Hook up control box, two lines of header information will appear on the screen: Program / clamp, etc. Upon connection, the current clamp information and tool serial # will appear. Tool is now ready.
9. To capture data- click Transfer, then click Capture Text, enter a file name and location, then click Start. **\*NOTE!** \*Data will not be saved unless "stop" is selected from this same menu.

Click OK

To check the cut-off delay timing, hold down the reset button on the breakout box for 3 seconds. You will see "Ready to check timing" appear on the screen. Activate the tool and it will display the delay duration in decimals of seconds. Hold down reset button for 3 seconds to return to main menu. See page 33.

# Tool Calibration

BAND-IT's use of the word calibration refers to the tool's electronic output being checked against a load measuring device. This is to insure that the electronic calculation of the output force based on the supply pressure is still matched up with the actual output force of the tool. To measure the actual output of the tool, BAND-IT has developed a Calibration Device (M28090). Call BAND-IT for more information.

The Calibration Device is installed onto the tool in place of the maintenance cover. The tension block of the tool presses up against the load cell on the calibration device when the trigger of the tool is depressed, allowing the tension force to be captured. The force is displayed on the readout. The direction of the tension force is shown by the white arrow. See the M28090 manual for further information.

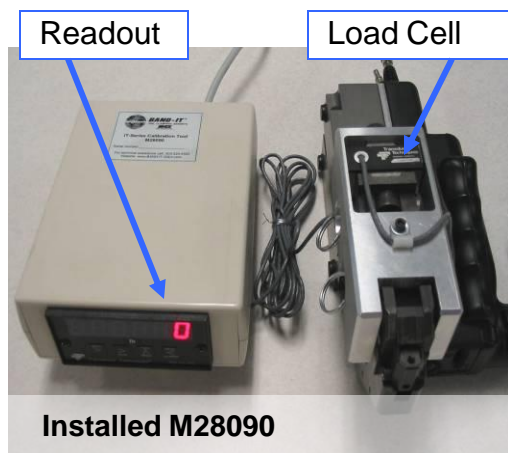
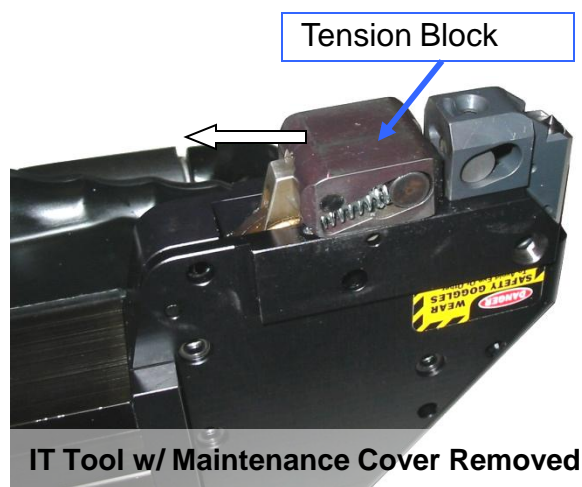

To check the calibration of the tool, attach the calibration device, hook up the air supply and actuate the trigger. Read the display once the tool stops moving. If the M28090 calibration device varies from the calculated force output from the data acquisition system by more than 15 lbs, the tool needs to be sent to BAND-IT-IDEX, Inc. for repair. Press the tool reset button to release the force and remove the calibration device. Be sure to clean and lubricate the maintenance cover before reinstalling the cover on the tool and inserting the Quick Release Pins shown on **page 7**.